

# TECHNICAL SPECIFICATION



## CARDS PRINT

Kudeljarski nasip prva 124g, 26000 Pancevo, Serbia

+381 11 41 41 540

info@cards-print.com | www.cards-print.com







CC CARD SPECIALISTS



## 1. CARDS SHAPES AND DIMENSIONS

### 1.1 MODEL 00 (Regular)

### 1.2 FAMILY CARDS

- 1.2.1 Model 01
- 1.2.2 Model 02
- 1.2.3 Model 05
- 1.2.4 Model 06
- 1.2.5 Model 07
- 1.2.6 Model 10

### 1.3 CUSTOM SHAPES

- 1.3.1 Model 04
- 1.3.2 Model 08
- 1.3.3 Model 09

### 1.4 XXL CARD

- 1.4.1 Round hole
- 1.4.2 Two round holes
- 1.4.3 Rectangular hole

### 1.5 LUGGAGE TAG

- 1.5.1 LGT 01
- 1.5.2 LGT 02

### 1.6 MAGNETIC STRIPE

- 1.6.1 Wide magnetic stripe
- 1.6.2 Narrow magnetic stripe

### 1.7 CHIP POSITION

- 1.7.1 CONTACTLESS CHIP
- 1.7.2 CONTACT CHIP

### 1.8 BARCODE

- 1.8.1 BARCODE FIELD
- 1.8.2 LABEL

## 2. INSTRUCTIONS FOR PRODUCING FILES

### 2.1 BASIC REQUIREMENTS

- 2.1.1 GENERAL
- 2.1.2 COLORS AND OBJECTS
- 2.1.3 ADDITIONAL ELEMENTS
- 2.2.4 PERSONALISATION

### 2.2 SETTING-UP THE CONTENT

- 2.2.1 BLEED
- 2.2.2 SAFE ZONE
- 2.2.3 PREPARATION OF BACKGROUND FOR PERFORATION

## 3. RECOMMENDATIONS

### 3.1 SOFTWARE

- 3.1.1 SOFTWARE SELECTION
- 3.1.2 EFFECTS AND FILTERS

### 3.2 COLORS

- 3.2.1 OVERPRINT
- 3.2.2 SATURATED BLACK COLOR

### 3.3 TYPES OF FILES

## 4. ADDITIONAL INFORMATION

### 4.1 SCOPE OF RESPONSIBILITY

### 4.2 CHECKLIST

# CHAPTER 1

## CARDS SHAPES AND DIMENSIONS

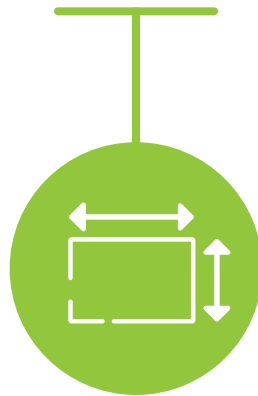



# 1.1 MODEL 00 (Regular)

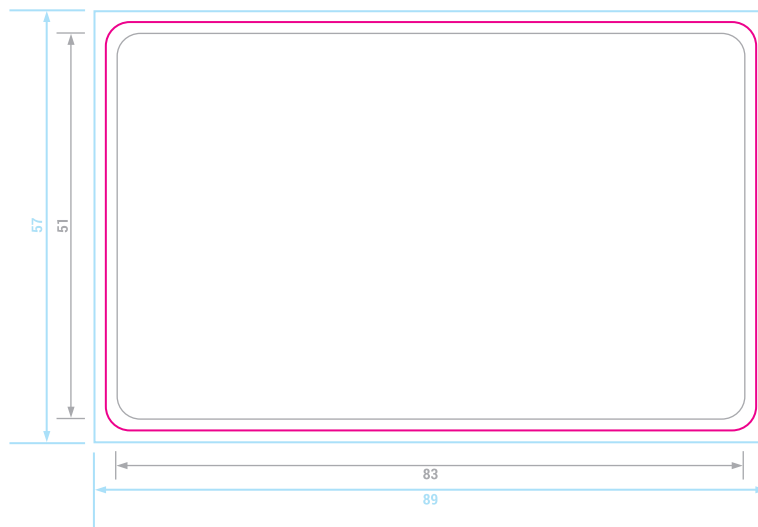

*Example of front and back*

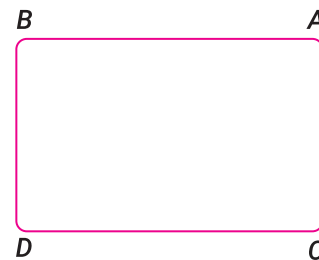

## DIMENSION

CARD DIMENSION		DIMENSION OF PREPARATION		Angle radius	Bleed
Width	Height	Width	Height		
86 mm	54 mm	89 mm	57 mm	3.18 mm	1.5 mm from the edge to the outside
					<b>Safe zone</b>
					1.5 mm from the edge to the inside

## 1.2 FAMILY CARDS

### 1.2.1 Model 01

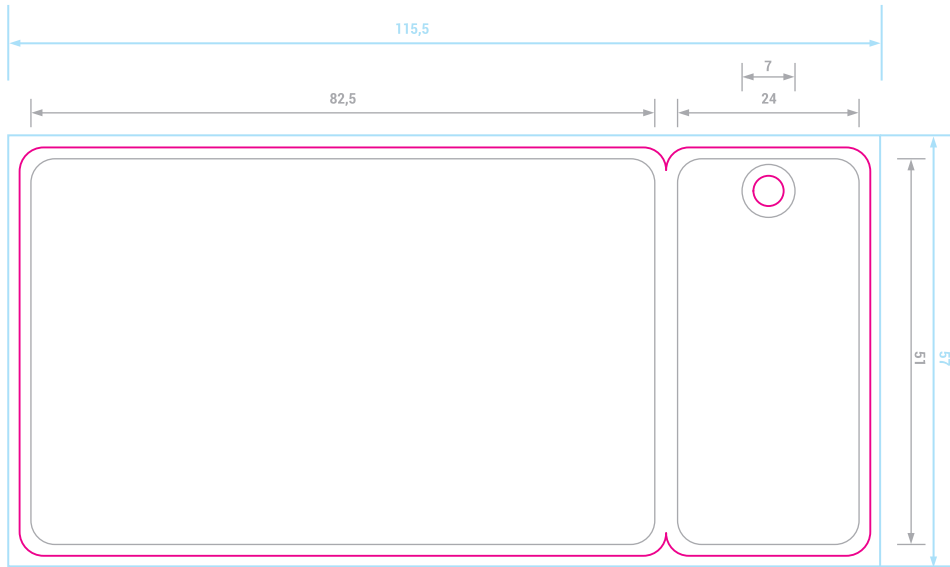

*Example of front and back*

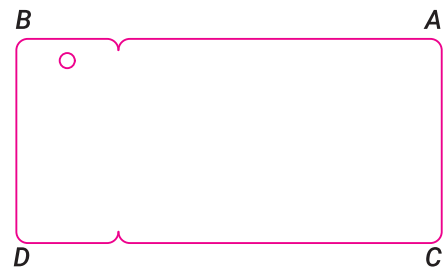
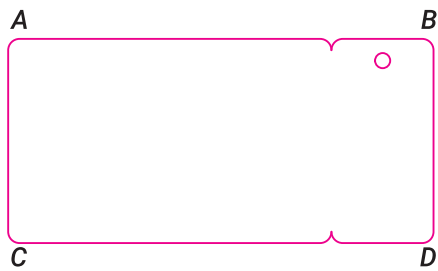

### DIMENSION

CARD DIMENSION		DIMENSION OF PREPARATION		Angle radius	Bleed
Width	Height	Width	Height		
112.5 mm	54 mm	115.5 mm	57 mm	3.18 mm	1.5 mm from the edge to the outside
					<b>Safe zone</b>
					1.5 mm from the edge to the inside

## 1.2 FAMILY CARDS

### 1.2.2 Model 02

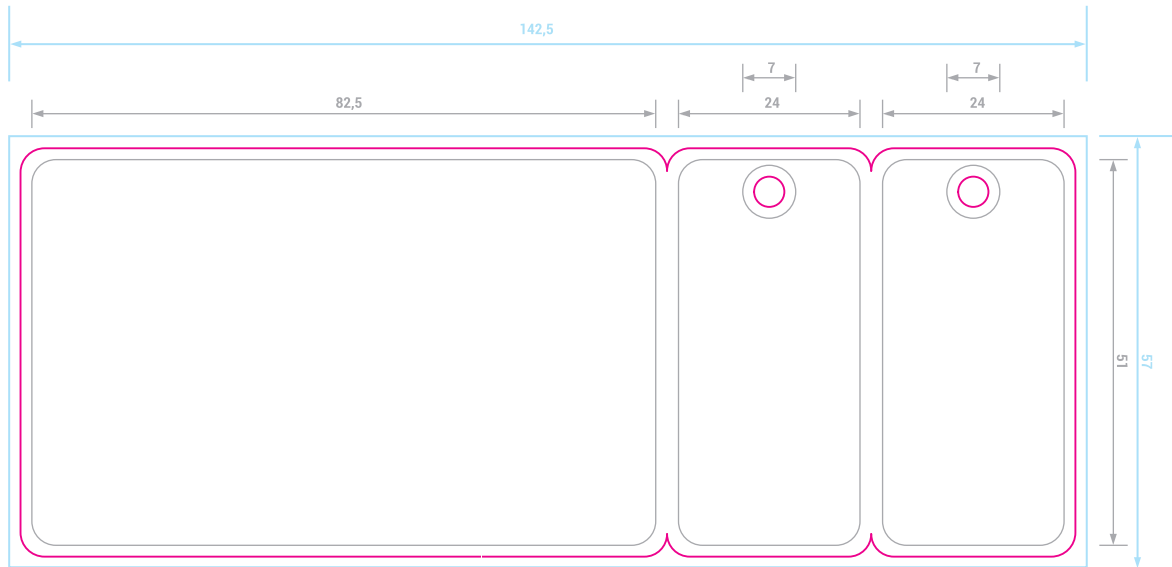

*Example of front and back*

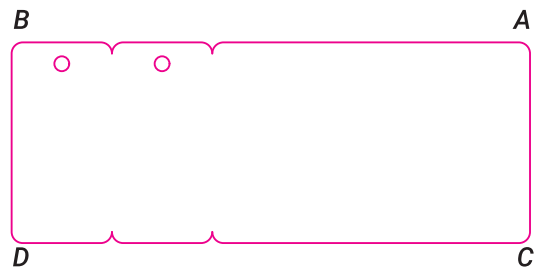
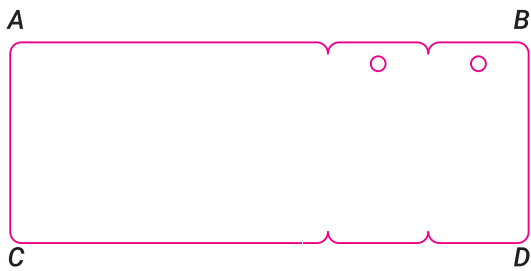

### DIMENSION

CARD DIMENSION		DIMENSION OF PREPARATION		Angle radius	Bleed
Width	Height	Width	Height		
139.5 mm	54 mm	142.5 mm	57 mm	3.18 mm	1.5 mm from the edge to the outside
					<b>Safe zone</b>
					1.5 mm from the edge to the inside



# 1.2 FAMILY CARDS

## 1.2.3 Model 05

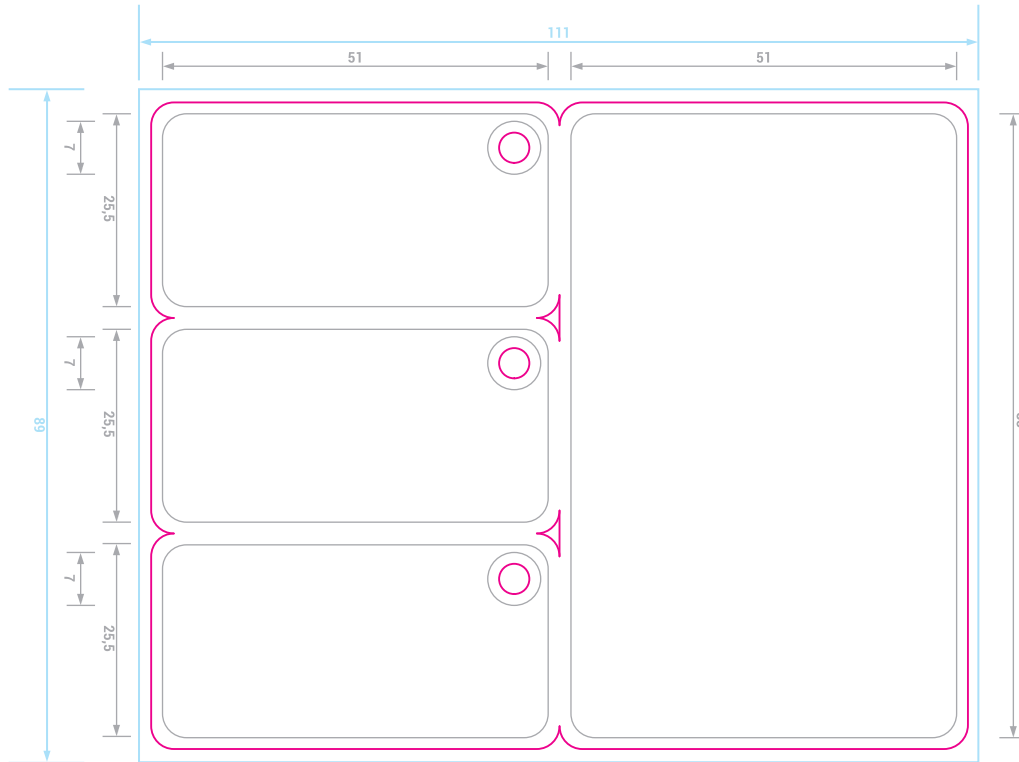

Example of front and back

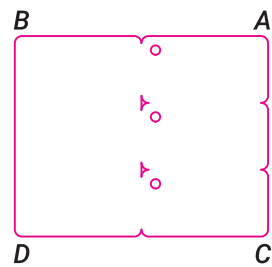
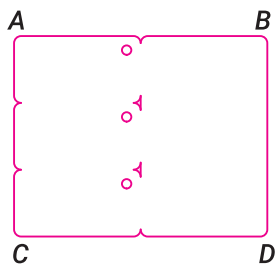

### DIMENSION

CARD DIMENSION		DIMENSION OF PREPARATION		Angle radius	Bleed
Width	Height	Width	Height		
108 mm	86 mm	111 mm	89 mm	3.18 mm	1.5 mm from the edge to the outside
					<b>Safe zone</b>
					1.5 mm from the edge to the inside

## 1.2 FAMILY CARDS

### 1.2.4 Model 06

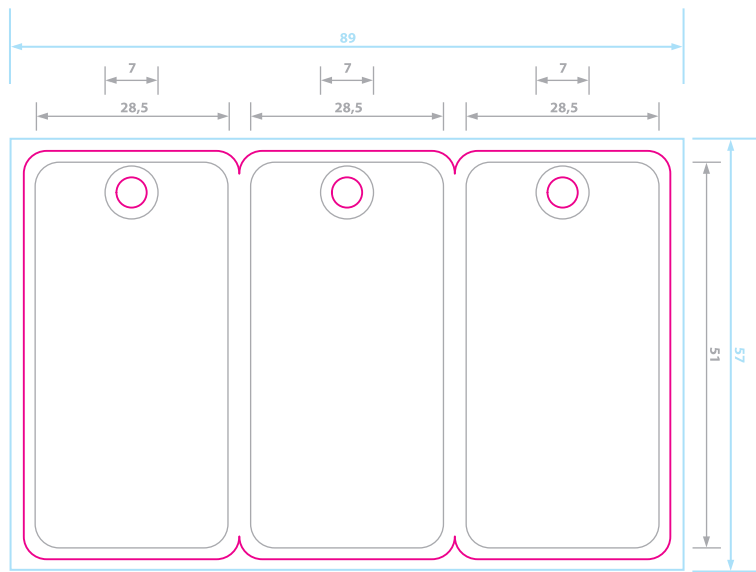

Example of front and back

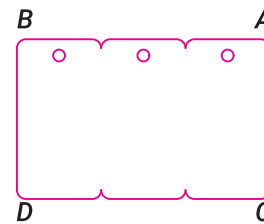
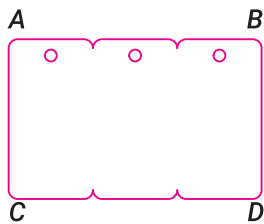

### DIMENSION

CARD DIMENSION		DIMENSION OF PREPARATION		Angle radius	Bleed
Width	Height	Width	Height		
86 mm	54 mm	89 mm	57 mm	3.18 mm	1.5 mm from the edge to the outside
					<b>Safe zone</b>
					1.5 mm from the edge to the inside

## 1.2 FAMILY CARDS

### 1.2.5 Model 07

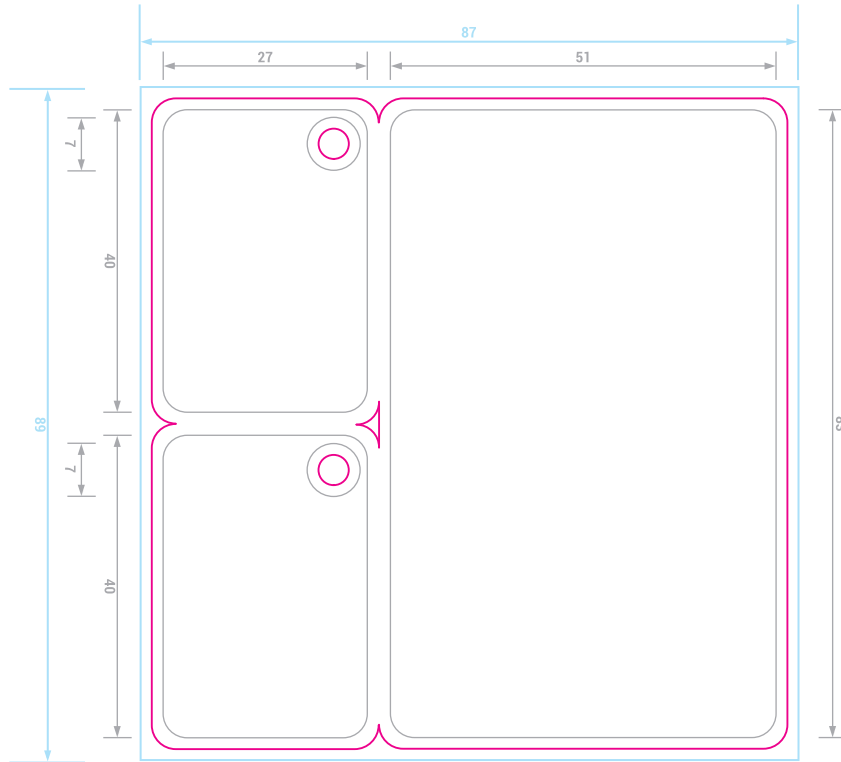

Example of front and back

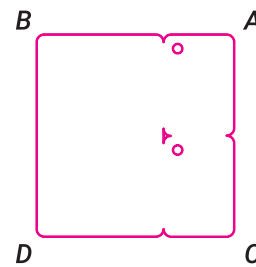
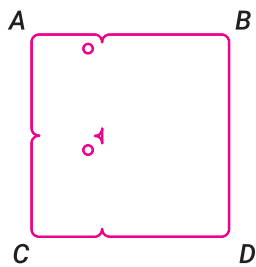

#### DIMENSION

CARD DIMENSION		DIMENSION OF PREPARATION		Angle radius	Bleed
Width	Height	Width	Height		
84 mm	86 mm	87 mm	89 mm	3.18 mm	1.5 mm from the edge to the outside
					<b>Safe zone</b>
					1.5 mm from the edge to the inside



## 1.2 FAMILY CARDS

### 1.2.6 Model 10

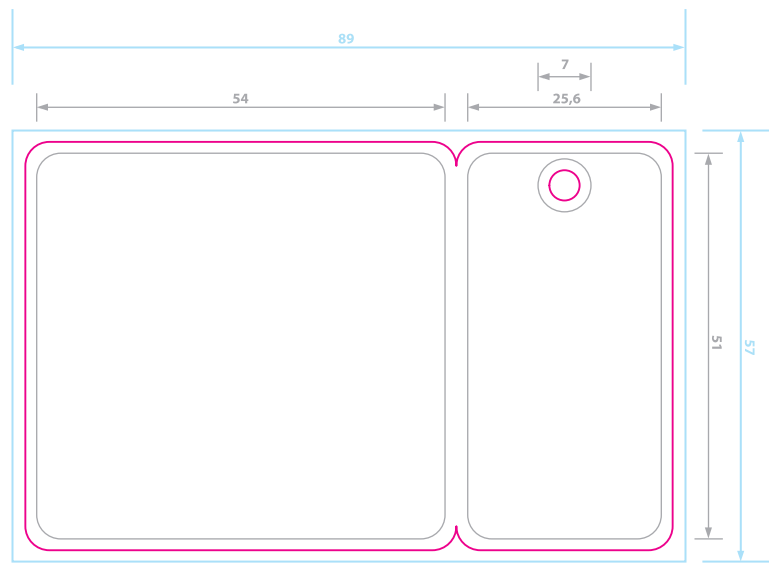

*Example of front and back*

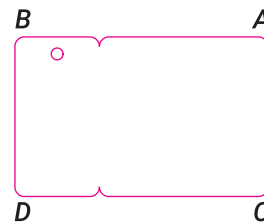
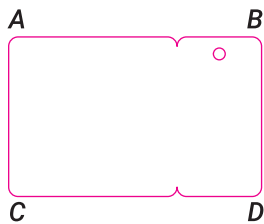

### DIMENSION

CARD DIMENSION		DIMENSION OF PREPARATION		Angle radius	Bleed
Width	Height	Width	Height		
86 mm	54 mm	89 mm	57 mm	3.18 mm	1.5 mm from the edge to the outside
				Hole diameter	Safe zone
				4 mm	1.5 mm from the edge to the inside

### 1.3 CUSTOM SHAPES

#### 1.3.1 Model 04

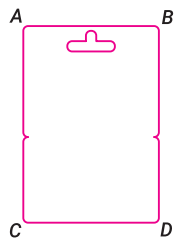
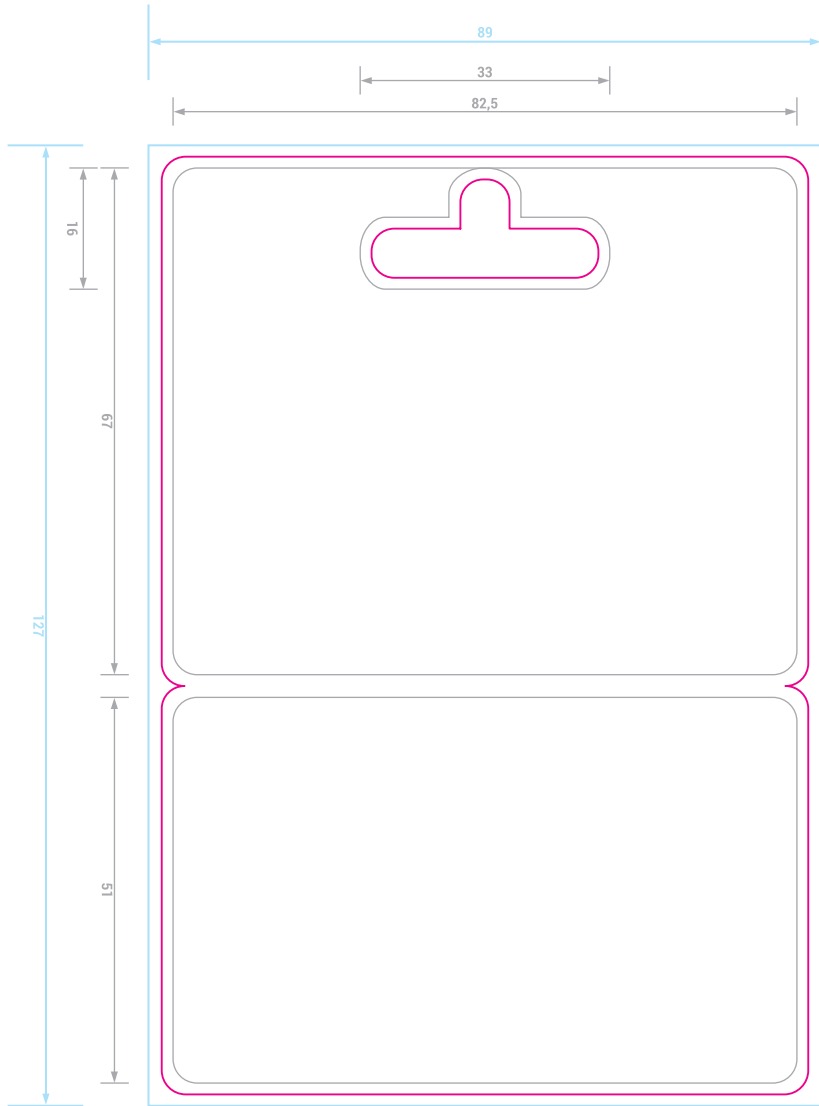

Example of front and back

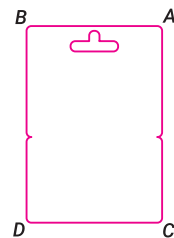

DIMENSION

CARD DIMENSION		DIMENSION OF PREPARATION		Angle radius	Bleed
Width	Height	Width	Height		
86 mm	124 mm	89 mm	127 mm	3.18 mm	1.5 mm from the edge to the outside
					<b>Safe zone</b>
					1.5 mm from the edge to the inside

### 1.3 CUSTOM SHAPES

#### 1.3.2 Model 08

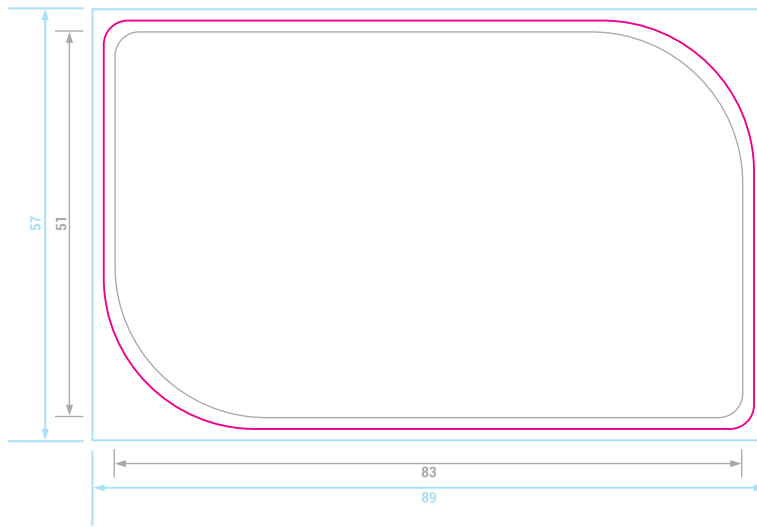

Example of front and back

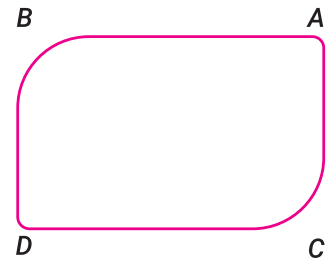
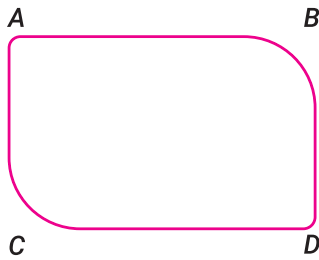

#### DIMENSION

CARD DIMENSION		DIMENSION OF PREPARATION		Angle radius	Bleed
Width	Height	Width	Height		
86 mm	54 mm	89 mm	57 mm	3.18 mm	1.5 mm from the edge to the outside
				Radius of larger angles	Safe zone
				20 mm	1.5 mm from the edge to the inside



### 1.3 CUSTOM SHAPES

#### 1.3.3 Model 09

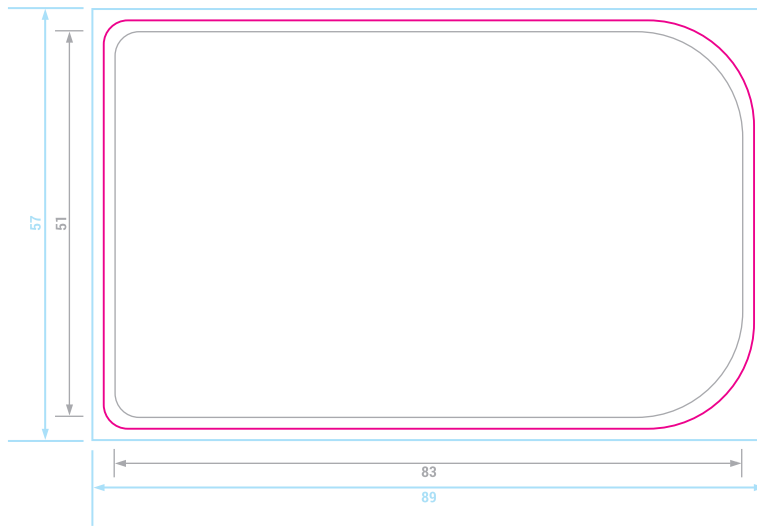

Example of front and back

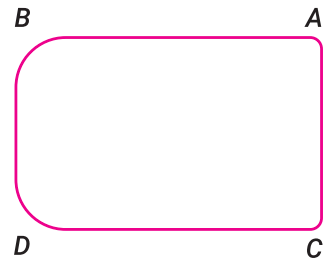

#### DIMENSION

CARD DIMENSION		DIMENSION OF PREPARATION		Angle radius	Bleed
Width	Height	Width	Height		
86 mm	54 mm	89 mm	57 mm	3.18 mm	1.5 mm from the edge to the outside
				Radius of larger angles	Safe zone
				14 mm	1.5 mm from the edge to the inside

## 1.4 XXL CARD

### 1.4.1 Round hole

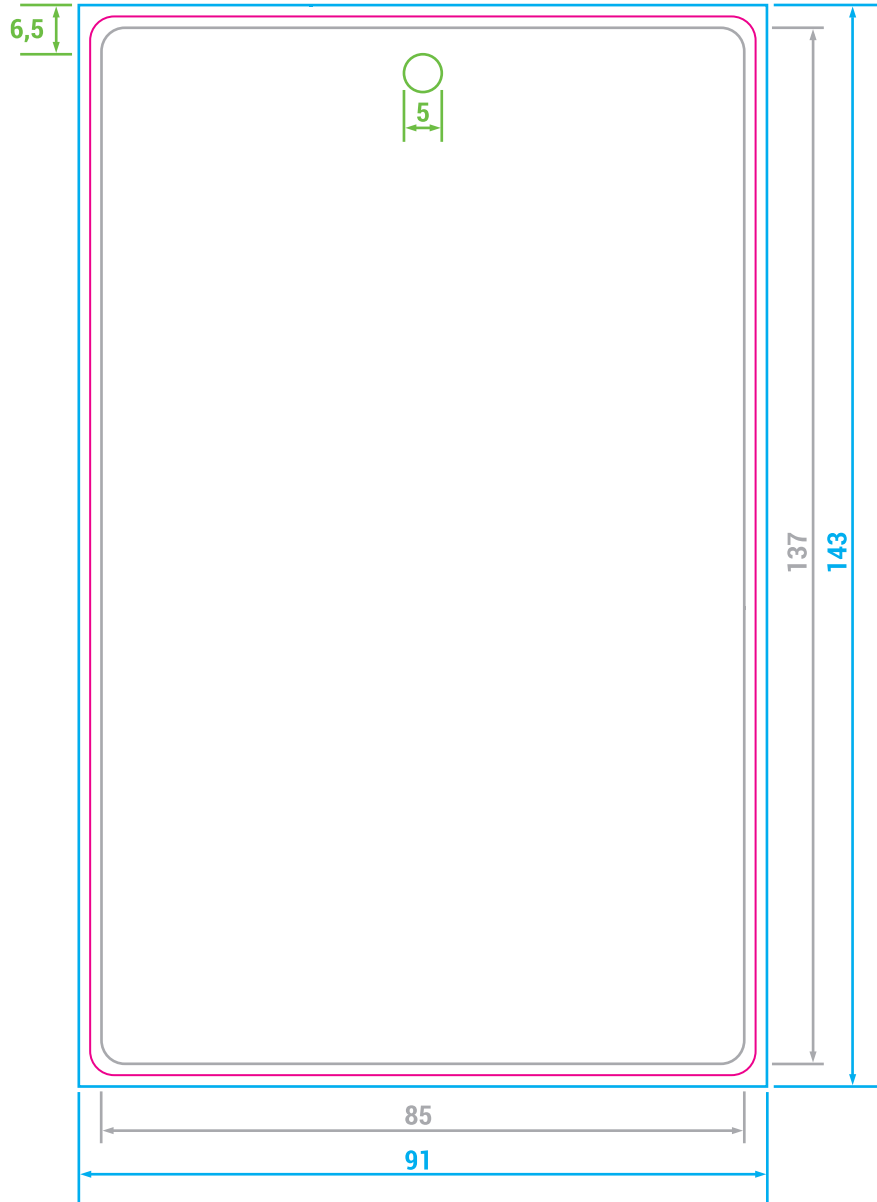

### DIMENSION

CARD DIMENSION		DIMENSION OF PREPARATION		Angle radius	Bleed
Width	Height	Width	Height		
88 mm	140 mm	91 mm	143 mm	3.18 mm	1.5 mm from the edge to the outside
				Hole diameter	Safe zone
				5 mm	1.5 mm from the edge to the inside

## 1.4 XXL CARD

### 1.4.2 Two round hole

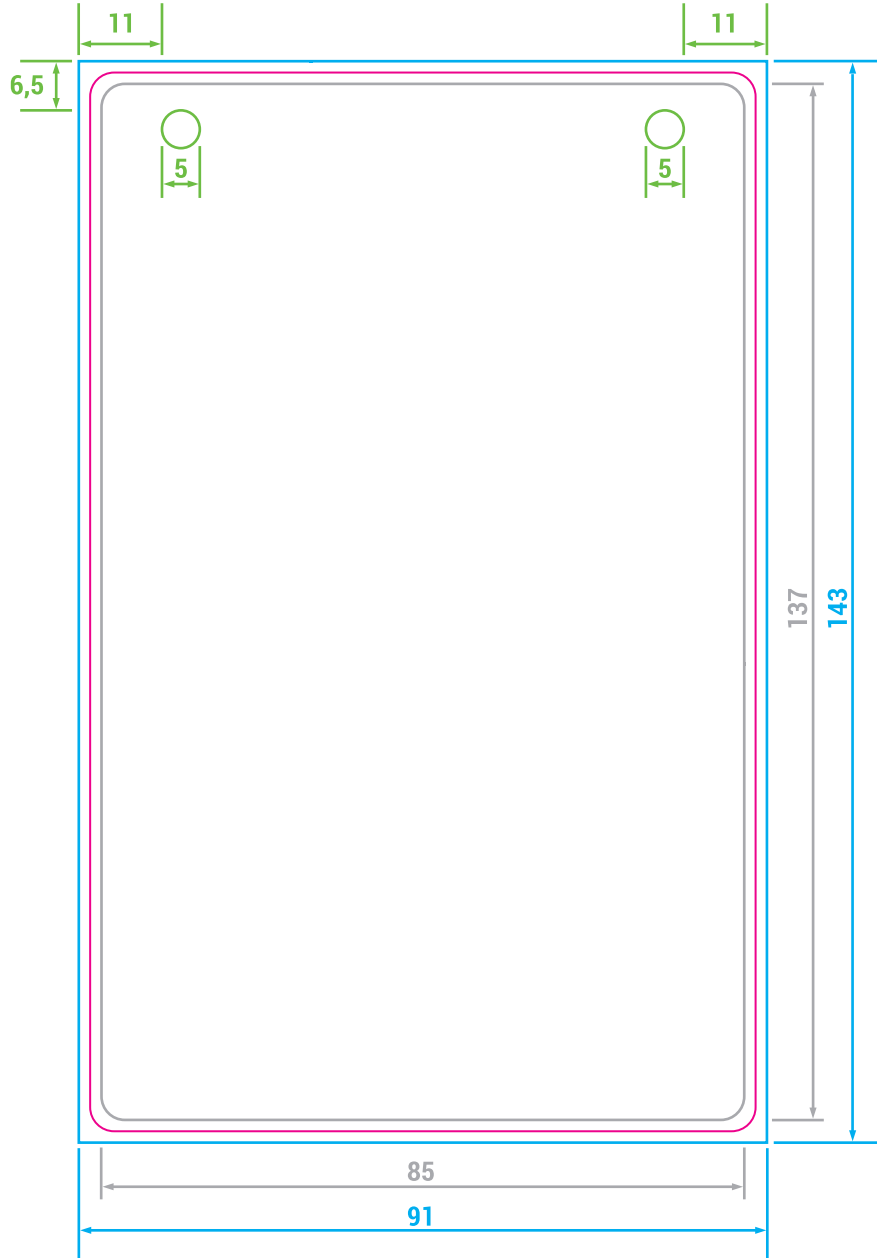

### DIMENSION

CARD DIMENSION		DIMENSION OF PREPARATION		Angle radius	Bleed
Width	Height	Width	Height		
88 mm	140 mm	91 mm	143 mm	3.18 mm	1.5 mm from the edge to the outside
				Hole diameter	Safe zone
				5 mm	1.5 mm from the edge to the inside



# 1.4 XXL CARD

## 1.4.3 Rectangular hole

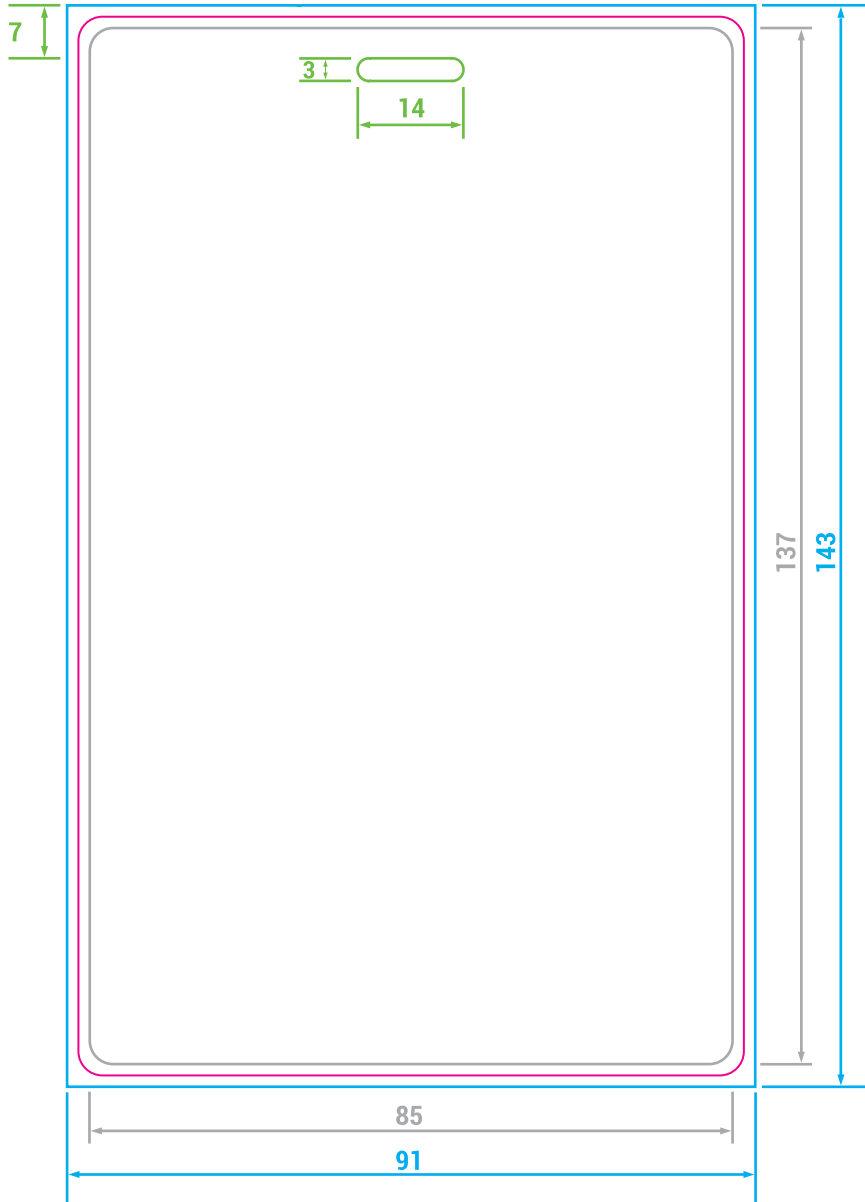

### DIMENSION

CARD DIMENSION		DIMENSION OF PREPARATION		Angle radius	Bleed	
Width	Height	Width	Height			
88 mm	140 mm	91 mm	143 mm	3.18 mm	1.5 mm from the edge to the outside	
				Hole height	Hole width	Safe zone
				3 mm	14 mm	1.5 mm from the edge to the inside

# 1.5 LUGGAGE TAG

## 1.5.1 LGT 01

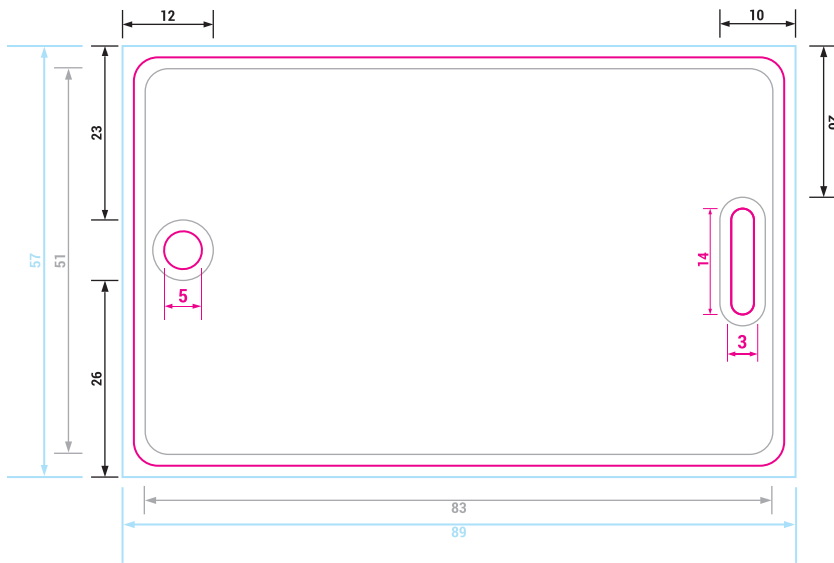

Example of front and back cards

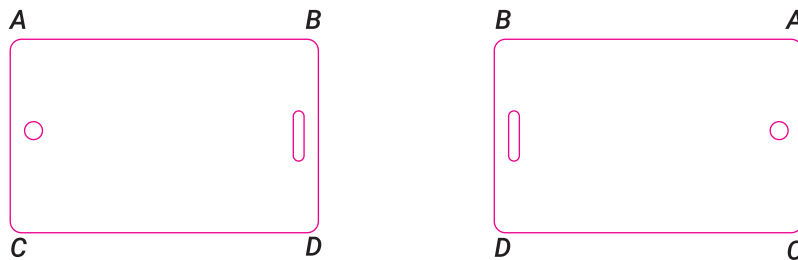

### DIMENSION

CARD DIMENSION		DIMENSION OF PREPARATION		Angle radius	Bleed
Width	Height	Width	Height		
86 mm	54 mm	89 mm	57 mm	3.18 mm	1.5 mm from the edge to the outside
DIMENSION OF RECTANGULAR HOLE				Hole diameter	Safe zone
		Width	Height	5 mm	1.5 mm from the edge to the inside
		14 mm	3 mm		

# 1.5 LUGGAGE TAG

## 1.5.2 LGT 02

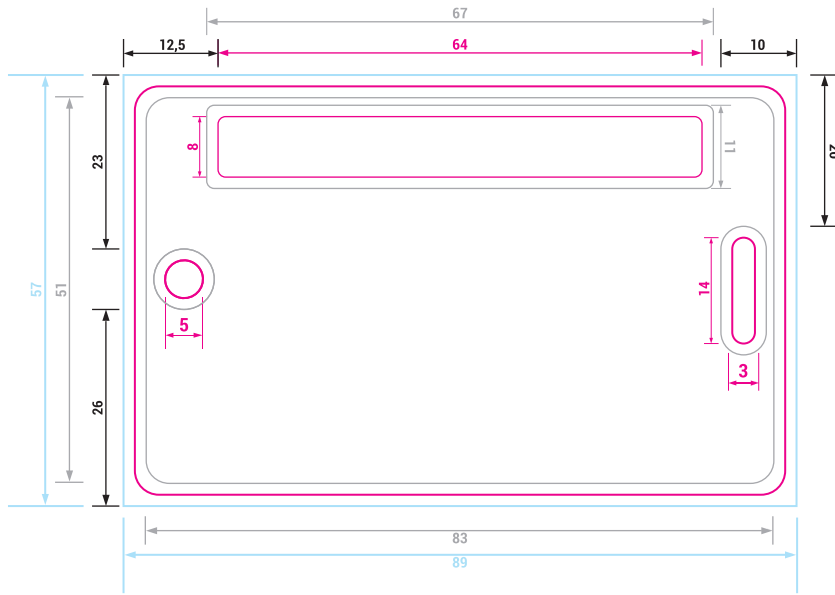

Example of front and back cards with a window

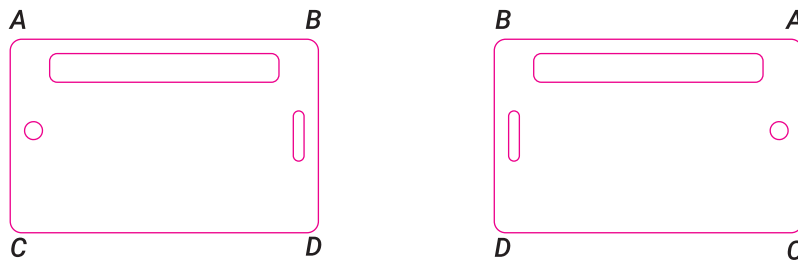

### DIMENZIJE

CARD DIMENSION		DIMENSION OF PREPARATION		Angle radius	Bleed
Width	Height	Width	Height	3.18 mm	
86 mm	54 mm	89 mm	57 mm	Window radius	1.5 mm from the edge to the outside
				1 mm	
WINDOW DIMENSION		DIMENSION OF RECTANGULAR HOLE		Hole diameter	Safe zone
Width	Height	Width	Height	5 mm	1.5 mm from the edge to the inside
64 mm	8 mm	14 mm	3 mm		

# 1.6 MAGNETIC STRIPE

## 1.6.1 Wide magnetic stripe

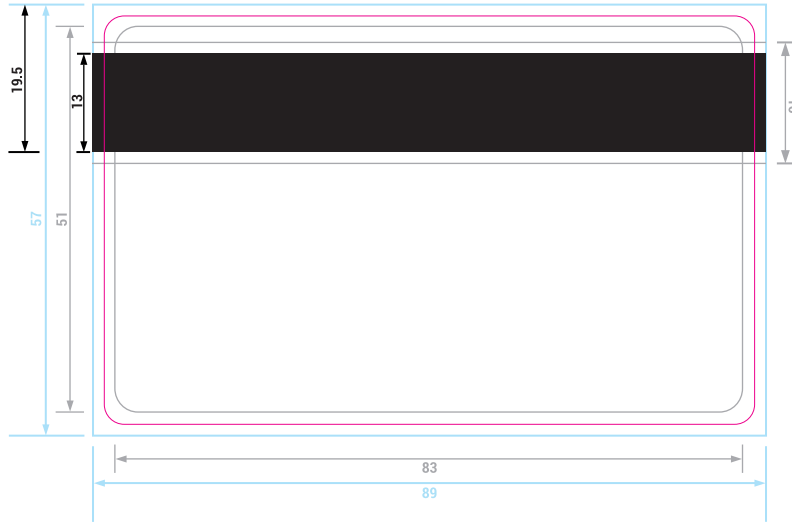

## 1.6.2 Narrow magnetic stripe

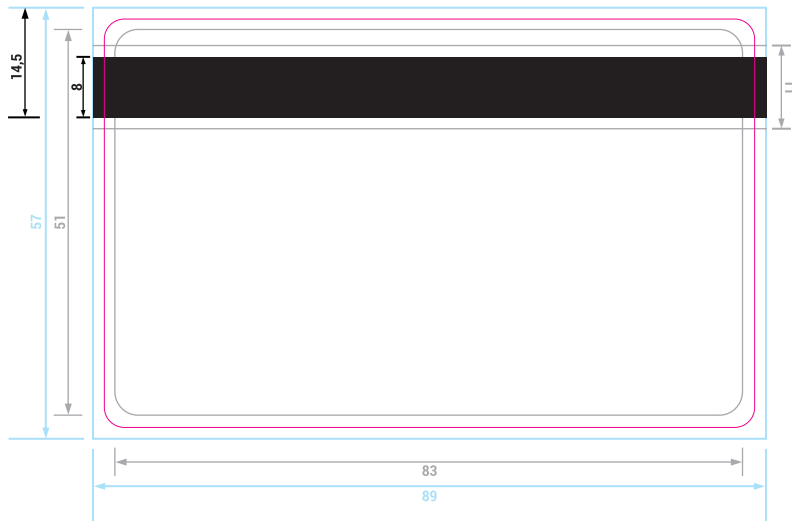

### DIMENSION

CARD DIMENSION		DIMENSION OF PREPARATION		Angle radius	Bleed
Width	Height	Width	Height		
86 mm	54 mm	89 mm	57 mm	3.18 mm	1.5 mm from the edge to the outside
HEIGHT OF MAGNETIC STRIPE		THE POSITION OF THE MAGNETIC STRIPE		HEIGHT OF MAGNETIC STRIPE	THE POSITION OF THE MAGNETIC STRIPE
8 mm		5 mm from the edge of the card		13 mm	5.5 mm from the edge of the card
<b>NARROW</b>				<b>WIDE</b>	

## 1.7 CHIP POSITION

### 1.7.1 CONTACTLESS CHIP

Contactless chips can be placed in any corner of cards and the example of the chip in the upper right corner of card's front side is given in the picture. Chips have antennas (green) while the chip is marked red.

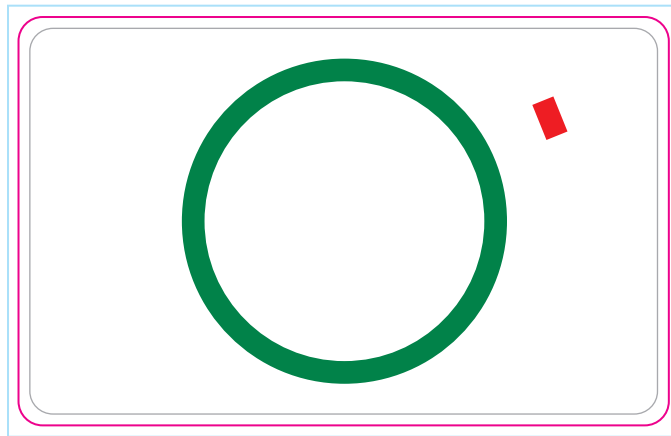

### 1.7.2 CONTACT CHIP

Contact chips have the exact position they must be placed in.

Chip 5528

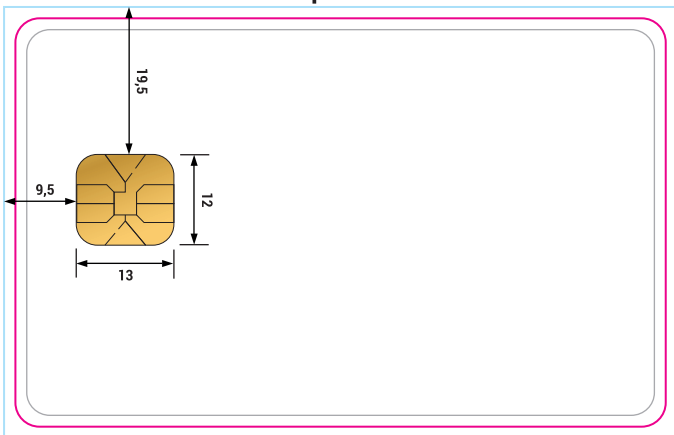

Chip 5542

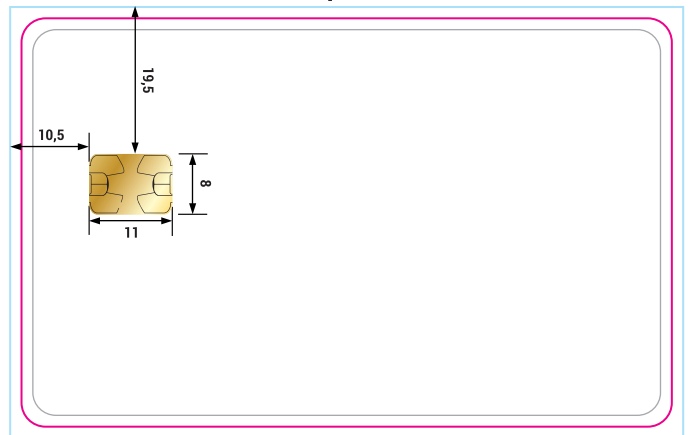



## 1.8 BARCODE

### 1.8.1 Barkocode field

If the number of barcode digits is 10 or less, the barcode field should be 13 x 30 mm or more.  
 If the number of barcode digits is 11 or more, the barcode field should be 15 x 40 mm or more.

**This specification varies depending on the density and type of barcode. You can also send an inquiry before sending the preparation.**

Barcode can be positioned in any part inside of the SAFE ZONE.

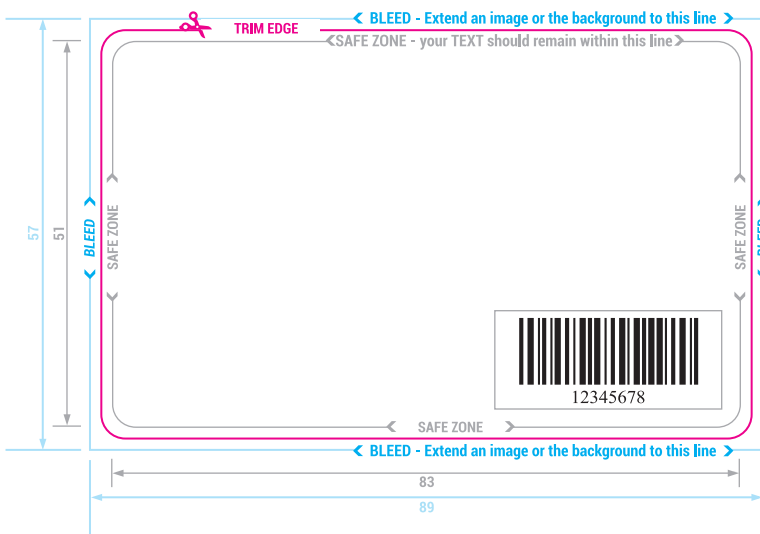

### 1.8.2 Label

A label is a sticker that sticks to a card and contains a barcode on it.  
 It has constant dimensions: 40 x 15 mm and is done on the side where the barcodes are made.  
 The barcode we have on the card is also on the label.  
 The position of the label must not be over the barcode field on the card.



## CHAPTER 2

# INSTRUCTIONS FOR PRODUCING FILES



## 2.1 BASIC REQUIREMENT

### 2.1.1 General

Preparation needs to be in CMYK colour mode so that the printing file can be used.

File must be prepared following the dimensions set.

All linked images within the working file must be **EMBEDDED**.

### 2.1.2 Colors and objects

Color and vector object values must be prepared in the CMYK color palette. The proposed total black coverage should not exceed 280%. This only applies to offset printing. While for all other types of printing only carbon (pure **K**) is used. The gray color should also be made of pure carbon to get the purest gray color possible.

Bitmap objects should be prepared at 300dpi in .JPG format.

### 2.1.3 Additional elements

Elements such as magnetic stripe, signature strip, holes and place for personalisation including random barcodes, contact and contactless chips must be marked for the position they can be placed or you want to place them.

## 2.1 BASIC REQUIREMENT

### 2.1.4 Personalisation

Personalisation elements, including barcodes, signature strips, hole types and other should be prepared in the form of vector object.

#### *Text personalisation*

All the text that is not personalised is converted into curves (make it unchangeable and uneditable but it will not request fonts on other computers).

For the text that is personalised, the font must be sent.

With ready-made preparation of personalisation files are not in any way corrected by the company **Cards Print-a**.

We convert fonts into curves by clicking on the text (select/object/all text objects if we want to mark the whole text), then type/create outlines(ctrl+shift+O).

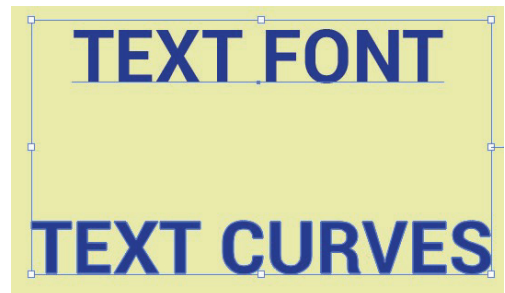

The example of the text preview in fonts and curves.

## 2.2 SETTING-UP THE CONTENT

### 2.2.1 Bleed

Graphic elements must be positioned up to the overhang line.

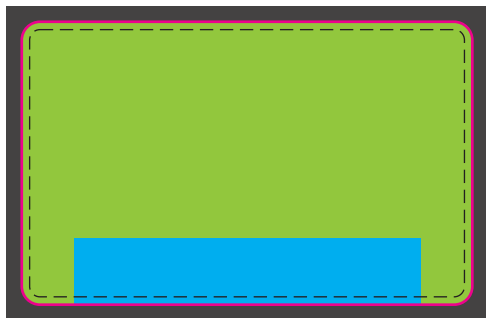
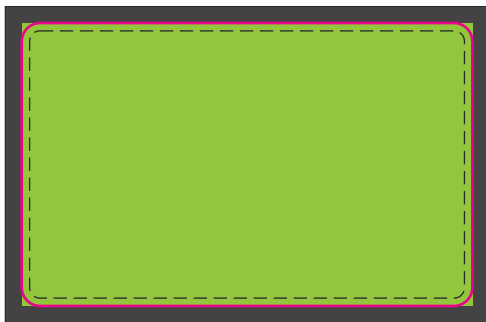

## 2.2 SETTING-UP THE CONTENT

### 2.2.2 Safe zone

To prevent graphic elements from getting to the cutting line, it is very important to position them within **safe zone**. Safe zone is 1.5mm from the cutting line.

Images need to be embedded when implementing them within your design. You can do it in Adobe *illustrator* by clicking the **'Embed'** button in the upper left corner of the *illustrator* window..

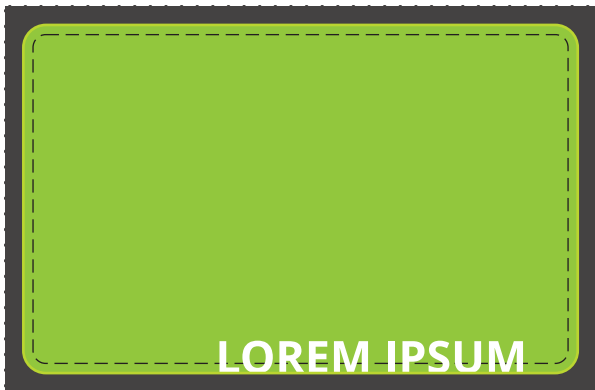

## 2.2 SETTING-UP THE CONTENT

### 2.2.3 Preparation of background for perforation

Background colours and elements must not have sharp gradation for perforation but they need to be gradient, one-colour background or graphic/image whose elements do not reach perforation line.

 WRONG

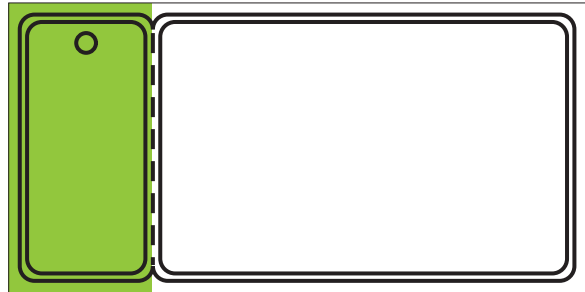
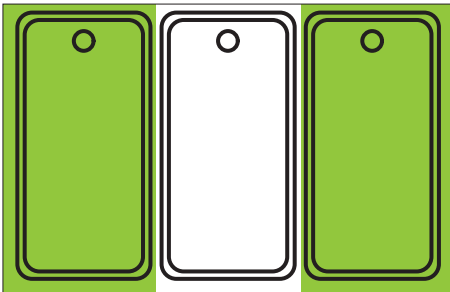

 CORRECT

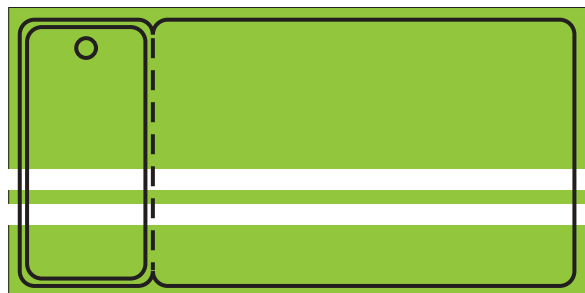
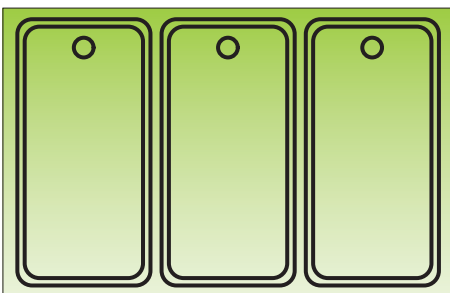
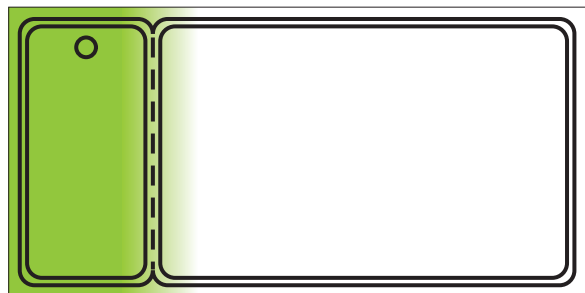
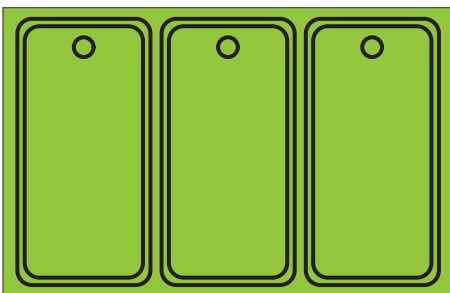

## CHAPTER 3

# RECOMMENDATIONS





## 3.1 SOFTWARE

### 3.1.1 Software selection

We recommend using softwares by the company **Adobe Systems Incorporated** to achieve the easiset compatibility with computing standards.

Each software has its own specific role and does not necessarily give the best solution for printing which also includes the software by the company **Adobe**.

For instance, it is usually mistakenly believed that one of **Adobe Photoshop** functions is saving in PDF format keeping vector layers. What is actually extracted is not a vector object with typical characteristics for this class but raster layers of bitmaps which makes a different type of object.

That's why efficient use of this object is not possible, so the printing quality could be lower than expected.

**This is exactly the reason why our choice is Adobe Illustrator which contains original vector objects and exports it in PDF in accordance with the standards.**

### 3.1.2 Effects and filters

Tools such as filters, shades, gradients etc. may vary through different versions of the software used. That is the reason why we strongly recommend a detailed checking of the preview we send you for confirmation as well as the sample if we deliver it to you.

## 3.2 COLORS

### 3.2.1 Overprint

Overprint option includes values of the covering colours. Covering colour means rewriting or reprinting over other colours.

A common mistake in preparation for printing is when black is not set to overprint but it covers them.

The most common problem in that case is black letters which are then very difficult to fit into printing. The most common lapse happening is photoshop files because it is not set to overprint black.

**OVERPRINT** option is not recommended for the type of printing we do.

### 3.2.2 Saturated black color

Due to a low level of black coverage in offset printing, it is advised to use specific methods to achieve deep black shade of the imprint. In our printing method, we recommend the following **CMYK** parameters:

**C:** 0%, **M:** 0%, **Y:** 0%, **K:** 100%

Different printing is used for different **CMYK** codes.

That is why we recommend that the elements should be vector and that correction is enabled.

## 3.3 TYPES OF FILES

*Files we recommend:*

- Ai
- PDF
- CDR
- EPS
- SVG

*Files we do not recommend:*

- Partial or complete inability to correct or adapt to the type of printing.
- PSD
  - JPG

## CHAPTER 4

# ADDITIONAL INFORMATION



## 4.1 SCOPE OF RESPONSIBILITY

Bear in mind that the company **Cards Print** is solely responsible for technical part of printing and shall not bear liability for the file client sends, the way it was created and the extent the abovementioned files match our specification.

Not following requests and recommendations listed in this specification can make the file unusable or cause poorer quality than expected. In case a client wants to change the file, our design team estimates the file and informs the client of the corrections requested that can be made.

## 4.2 CHECKLIST

- Correct file (Vector format)
- Vector elements within the file
- Following safe zone
- Leaving bleed
- Dimensions in accordance with specification
- Colours is CMYK
- Text in curves
- Fonts for personalisation
- Position hole, chip and magnetic stripe
- Images Embedded within the file (JPG, 300dpi)
- Effects, filters and overprint

•If you make the model with perforation:

- Background with perforation